

DS-2SF8C425MXG-ELW/26 4 MP 25 × TandemVu PTZ Camera



Hikvision has been dedicated to develop products with security since established. Hikvision always follows security by design principle and has adopted many methods of security technologies into our product development lifecycle, including terminal security, data security, application security, network security, and privacy protection. In the meantime, the security technologies used by Hikvision are all in compliance with local applicable laws and safety regulations. These security measures could enhance product's cyber security protection capability and protect your devices as well as your data from malicious cyber attacks.

- Captures a large area and great details at the same time
- High quality imaging with 6 MP resolution for bullet channel
- 24/7 colorful imaging and excellent low-light performance with DarkFighter technology
- Panoramic channel tilt adjustable from 12° to 24°
- Secures an expansive area with 25 × optical zoom and 16 × digital zoom
- Expansive night view with up to 30 m white light distance and 300 m IR distance
- Supports deep learning functions
- Water and dust resistant (IP67) and vandal resistant (IK10)

▪ Specification

| Camera | |
|------------------------|--|
| Image Sensor | [Panoramic channel] 1/1.8" Progressive Scan CMOS, [PTZ channel] 1/1.8" Progressive Scan CMOS |
| Min. Illumination | [PTZ channel] Color: 0.0005 Lux @ (F1.3, AGC ON), B/W: 0.0001 Lux @ (F1.3, AGC ON), 0 lux with IR, [Panoramic channel] Color: 0.005 Lux @ (F1.4, AGC ON), B/W: 0.001 Lux @ (F1.4, AGC ON), 0 Lux with light |
| Shutter Speed | 1 s to 1/30000 s |
| Slow Shutter | Yes |
| Day & Night | [Panoramic channel] Color, [PTZ channel] IR cut filter |
| Zoom | [PTZ channel] 25 × optical, 16 × digital |
| Max. Resolution | [Panoramic channel] 3632 × 1632, [PTZ channel] 2560 × 1440 |
| Lens | |
| FOV | [Panoramic channel] horizontal field of view: 190° ± 5°, vertical field of view: 80° ± 5°, [PTZ channel] horizontal field of view: 58.5° to 3.1°, vertical field of view: 34° to 1.7°, diagonal field of view: 65.8° to 3.5° |
| Zoom Speed | [Panoramic channel] No, [PTZ channel] approx. 5.6 s |
| Focus | Auto, semi-auto, manual |
| Focal Length | [Panoramic channel] 2.8 mm, [PTZ channel] 6 to 150 mm |
| Aperture | [Panoramic channel] F1.0, [PTZ channel] F1.6 |
| Illuminator | |
| Supplement Light Range | [Panoramic channel] white light: up to 30 m, [PTZ channel] IR: up to 300 m |
| Smart Supplement Light | Yes |
| PTZ | |
| Movement Range (Pan) | 360° endless |
| Movement Range (Tilt) | [Panoramic channel] 12° to 24°, [PTZ channel] -20° to 90° |
| Pan Speed | [PTZ channel] pan speed: configurable from 0.1° to 160°/s, preset speed: 240°/s |
| Tilt Speed | [PTZ channel] tilt speed: configurable from 0.1° to 120°/s, preset speed 200°/s, [Panoramic channel] tilt speed configurable |
| Proportional Pan | [Panoramic channel] No, [PTZ channel] Yes |
| Presets | 300 |
| Patrol Scan | 8 patrols, up to 32 presets for each patrol |
| Pattern Scan | 4 pattern scans, record time over 10 minutes for each scan |
| Power-off Memory | Yes |
| Park Action | Preset, pattern scan, patrol scan, auto scan, tilt scan, random scan, frame scan, panorama scan |
| 3D Positioning | Yes |
| PTZ Status Display | Yes |
| Preset Freezing | Yes |
| Scheduled Task | Preset, pattern scan, patrol scan, auto scan, tilt scan, random scan, frame scan, panorama scan, dome reboot, dome adjust, aux output |

| Video | |
|-----------------------------|---|
| Main Stream | [PTZ channel] 50 Hz: 25 fps (2560 × 1440, 1920 × 1080, 1280 × 960, 1280 × 720), 60 Hz: 30 fps (2560 × 1440, 1920 × 1080, 1280 × 960, 1280 × 720),[Panoramic channel] 50 Hz: 25 fps (3680 × 1656 , 3632 × 1632), 60 Hz: 30 fps (3680 × 1656 , 3632 × 1632) |
| Sub-Stream | [PTZ channel] 50 Hz: 25 fps (704 × 576 ,640 × 480 ,352 × 288), 60 Hz: 30 fps (704 × 576, 640 × 480, 352 × 288),[Panoramic channel] 50 Hz: 25 fps (1200 × 536, 960x432), 60 Hz: 30 fps (1200 × 536, 960x432) |
| Third Stream | [PTZ channel] 50 Hz: 25 fps (1920 × 1080, 1280 × 960, 1280 × 720, 704 × 576, 640 × 480, 352 × 288), 60 Hz: 30 fps (1920 × 1080, 1280 × 960, 1280 × 720, 704 × 480, 640 × 480, 352 × 240),[Panoramic channel] No |
| Video Compression | Main stream: H.265+/H.265/H.264+/H.264, Sub-stream: H.265/H.264/MJPEG, Third stream: H.265/H.264/MJPEG |
| Video Bit Rate | 32 Kbps to 16 Mbps |
| H.264 Type | Baseline profile,Main profile,High profile |
| H.265 Type | Main profile |
| Scalable Video Coding (SVC) | H.264 and H.265 encoding |
| Region of Interest (ROI) | 8 fixed regions for each stream |
| Audio | |
| Audio Compression | G.711,G.722.1,G.726,MP2L2,PCM,AAC-LC |
| Audio Bit Rate | 32 to 192 Kbps (MP2L2),16 to 64Kbps (AAC-LC) |
| Audio Sampling Rate | 8 kHz,16 kHz,32 kHz,48 kHz |
| Environment Noise Filtering | Yes |
| Network | |
| API | ISUP,ISAPI,SDK,ONVIF |
| Network Storage | NAS (NFS, SMB/CIFS),auto network replenishment (ANR) |
| Protocols | IPv4/IPv6,HTTP,HTTPS,802.1X,QoS,SMTP,UPnP,SNMP,DNS,DDNS,NTP,RTSP,RTCP,RTP,TCPIP,UDP,IGMP,ICMP,DHCP,PPPoE,Bonjour,FTP |
| Simultaneous Live View | Up to 20 channels |
| User/Host | Up to 32 users. 3 user levels: administrator, operator, and user |
| Security | Password protection,complicated password,IP address filter,HTTPS encryption,802.1X authentication (EAP-TLS, EAP-LEAP, EAP-MD5),host authentication (MAC address),watermark |
| Client | iVMS-4200,HikCentral Pro,Hik-Connect |
| Web Browser | IE 10+, Chrome 57+, Firefox 52+, Safari 12+ |
| Image | |
| Wide Dynamic Range (WDR) | [Panoramic channel] 120 dB, [PTZ channel] 120 dB |
| Day/Night Switch | Day,night,auto,schedule |
| Image Enhancement | HLC,3D DNR |
| Privacy Mask | [Panoramic channel] 8 programmable polygon privacy masks, [PTZ channel] 24 programmable polygon privacy masks; mask color or mosaic configurable |
| Defog | Digital defog |
| Image Stabilization | EIS (Built-in gyroscope to improve EIS performance) |
| Regional Exposure | Yes |
| Regional Focus | [Panoramic channel] No, [PTZ channel] Yes |

| | |
|-------------------------------|--|
| Image Settings | Saturation, brightness, contrast, sharpness, gain, and white balance adjustable by client software or web browser |
| Image Parameters Switch | Yes |
| SNR | ≥ 52 dB |
| Supplement Detection | |
| Satellite Positioning | No |
| Gyroscope | Yes |
| Compass | No |
| Interface | |
| Ethernet Interface | 1 RJ45 100M self-adaptive Ethernet port |
| On-board Storage | Built-in memory card slot, support microSD/microSDHC/microSDXC card, up to 256 GB |
| Alarm | 7 input(s), 2 output(s) |
| Audio | 1 input (line in), max. input amplitude: 2-2.4 vpp, input impedance: 1 K Ω \pm 10%, 1 output (line out), line level, output impedance: 600 Ω |
| RS-485 | 1 RS-485 (Half duplex, HIKVISION, Pelco-P, Pelco-D, self-adaptive) |
| Reset | Yes |
| Event | |
| Basic Event | [PTZ channel & panoramic channel] alarm input and output, exception,[PTZ channel] video tampering alarm |
| Smart Event | [Panoramic channel] line crossing detection, intrusion detection, region entrance detection, region exiting detection,[PTZ channel] line crossing detection, intrusion detection, region entrance detection, region exiting detection |
| Linkage | [Panoramic channel] Upload to FTP/NAS/memory card, notify surveillance center, send email, trigger alarm output, trigger recording, audible warning, white light flashing, [PTZ channel] Upload to FTP/NAS/memory card, notify surveillance center, send email, trigger alarm output, trigger recording, and PTZ actions (such as preset, patrol scan, pattern scan) |
| Smart Tracking | [PTZ channel] yes |
| Smart Linkage | Manual tracking, tracking takeover, linked tracking capture |
| Deep Learning Function | |
| Multi-Target-Type Detection | [PTZ channel] Supports simultaneous detection and capture of human body and face |
| Perimeter Protection | PTZ and Panoramic channel both support |
| General | |
| General Function | mirror,password protection |
| Power | 36 VDC \pm 25%, max. 60 W, Hi-PoE,including max. 6 W for heater and max. 3 W for supplement light of panoramic channel, and max. 6 W for heater and max. 12 W for supplement light of PTZ channel |
| Operating Condition | -40 $^{\circ}$ C to 70 $^{\circ}$ C (-40 $^{\circ}$ F to 158 $^{\circ}$ F). Humidity 95% or less (non-condensing),For speaker: -30 $^{\circ}$ C to 55 $^{\circ}$ C (-22 $^{\circ}$ F to 131 $^{\circ}$ F) |
| Wiper | Yes |
| Demist | Yes |
| Material | ADC12 |
| Dimension | \varnothing 290 mm \times 453.2 mm (\varnothing 11.42" \times 17.84") |
| Weight | Approx. 10.5 kg (23.15 lb.) |

| | |
|-----------------|---|
| Language | 33 languages: English, Russian, Estonian, Bulgarian, Hungarian, Greek, German, Italian, Czech, Slovak, French, Polish, Dutch, Portuguese, Spanish, Romanian, Danish, Swedish, Norwegian, Finnish, Croatian, Slovenian, Serbian, Turkish, Korean, Traditional Chinese, Thai, Vietnamese, Japanese, Latvian, Lithuanian, Portuguese (Brazil), Ukrainian |
| Approval | |
| EMC | FCC (47 CFR Part 15, Subpart B),CE-EMC (EN 55032: 2015, EN 61000-3-2: 2019, EN 61000-3-3: 2013 + A1: 2019, EN 50130-4: 2011 + A1: 2014),RCM (AS/NZS CISPR 32: 2015),IC (ICES-003: Issue 7),KC (KN 32: 2015, KN 35: 2015) |
| Safety | UL (UL 62368-1),CB (IEC 62368-1: 2014 + A11),CE-LVD (EN 62368-1: 2014/A11: 2017),BIS (IS 13252 (Part 1): 2010/IEC 60950-1: 2005),LOA (IEC/EN 60950-1) |
| Environment | CE-RoHS (2011/65/EU),WEEE (2012/19/EU),Reach (Regulation (EC) No 1907/2006) |
| Protection | IP67 (IEC 60529-2013),TVS 6000 V lightning protection, surge protection and voltage transient protection,IK10 (IEC 62262:2002) |

▪ DORI

The DORI (detect, observe, recognize, identify) distance gives the general idea of the camera ability to distinguish persons or objects within its field of view. It is calculated based on the camera sensor specification and the criteria given by EN 62676-4: 2015.

| DORI | Detect | Observe | Recognize | Identify |
|----------------------------------|---------|---------|-----------|----------|
| Definition | 25 px/m | 63 px/m | 125 px/m | 250 px/m |
| [Bullet channel] Distance | 77.0m | 30.5m | 15.4m | 7.7m |
| [PTZ channel] Distance (Tele) | 2965.5m | 1176.8m | 593.1m | 296.6m |

▪ Available Model



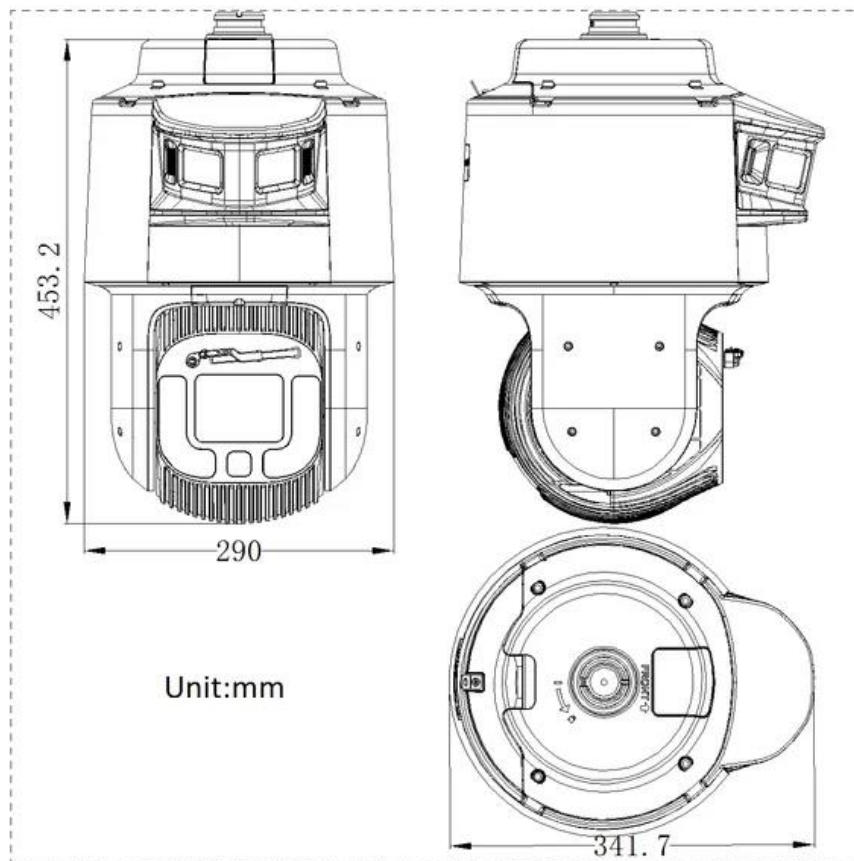

DS-2SF8C425MXG-ELW/26(F0)









▪ Dimension



▪ **Accessory**

▪ **Optional**

| DS-1603ZJ-P Wall mount | DS-1668ZJ-P Pendant Mount | DS-1668ZJ(20)-P Pendant Mount | DS-1673ZJ-P Vertical pole mount | DS-1603ZJ-Pole-P Vertical pole mount |
|---|---|---|---|---|
|  |  |  |  |  |

| | | | | |
|--|--|---|---|---|
|  |  |  |  |  |
| <p>DS-1619ZJ-HP2 Others</p> | <p>DS-1684ZJ-P Vertical pole mount</p> | | | |
|  |  | | | |
|  |  | | | |

Headquarters

No.555 Qianmo Road, Binjiang District,
Hangzhou 310051, China
T +86-571-8807-5998
www.hikvision.com



Follow us on social media to get the latest product and solution information.



Hikvision



HikvisionHQ



HikvisionHQ



Hikvision_Global



Hikvision
Corporate Channel



hikvisionhq