

Cerberus™ PRO

## Test units and accessories

FDUL221, DX791, RE6, REF8, REF8-S, REF8-C, RE8, RE8-S, RE8-C, RE7T, RE8ST, RE8STCO, RE8-CO, RE7T-x, RE10, FDUM29x, FDLU291, LE3, StabexHF



### Test units to test detectors and detector lines for FS720 fire detection installations.

- Detector exchanger DX791 for the efficient installation and removal of Cerberus point detectors
- Line tester FDUL221 for diagnosing detector lines
- Detector tester RE6 for use with environmentally-friendly test gas REF8, REF8-S, REF8-C
- Detector tester RE7T with hot air generator, RE8ST with smoke capsule RE8-S, RE8ST-CO with smoke capsule RE8-S, capsule RE8-CO, and CO capsule
- Detector tester RE10 for undertaking a function check on linear smoke detectors
- Telescope rods FDUM291/292 for extending detector exchangers and other testers

## Properties

- 4-line display with 20 characters per line
- Menu-guided operation
- Supply with battery or via network adapter
- Possible to update the device software (firmware) via the MCL-USB adapter (radio) FDUZ227 and via a PC
- Environmentally friendly processing
- Reusable materials
- Electronic parts and synthetic materials can be easily separated

## Function

Different functions can be called up, e.g.,:

- Number of devices found at A and B connection
- Line errors found, location of the line error
- Short-circuit, open line, ground fault with indication of which conductor/s
- Total resistance is too high and/or charge voltage at the line end is too low
- Data transmission fault due to line capacitance being too high
- Browsing from detector to detector with screen displaying type and serial number
- Display of branches and choice of branch for scrolling
- Activating the internal alarm indicator of the selected detector and recognizing the connected alarm sounder
- Extended operation and functionality on PC with line tester software FXS2017
- The line tester software FXS2017 is included in the scope of delivery of the line tester FDUL221.

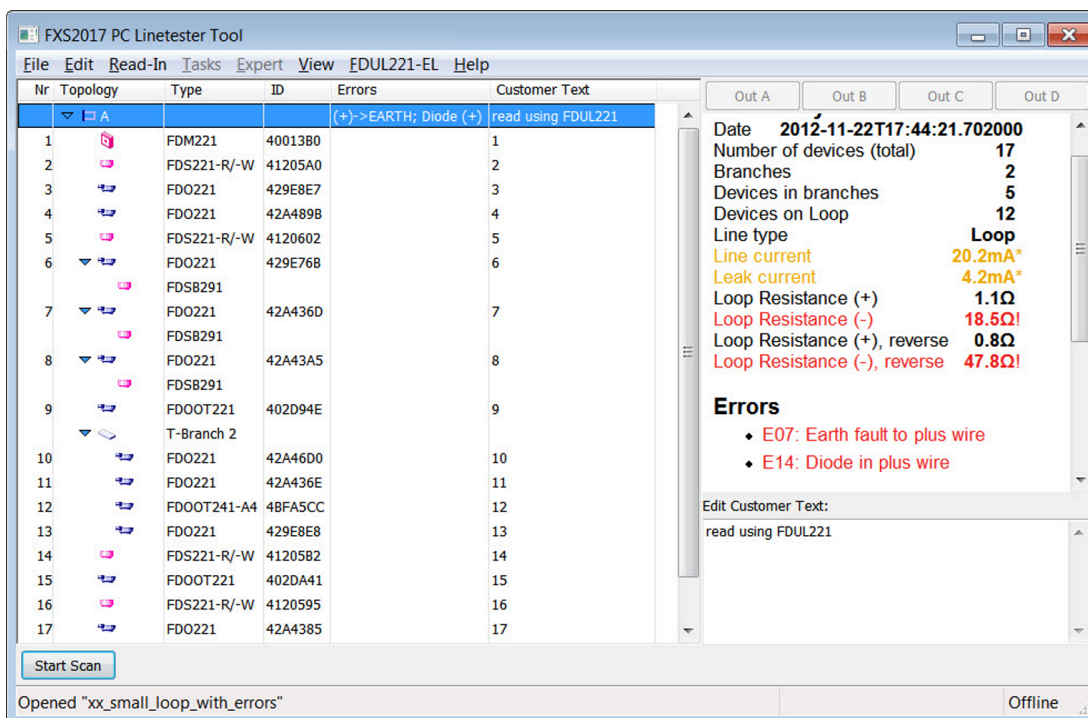

Fig. 1: Line tester software FXS2017

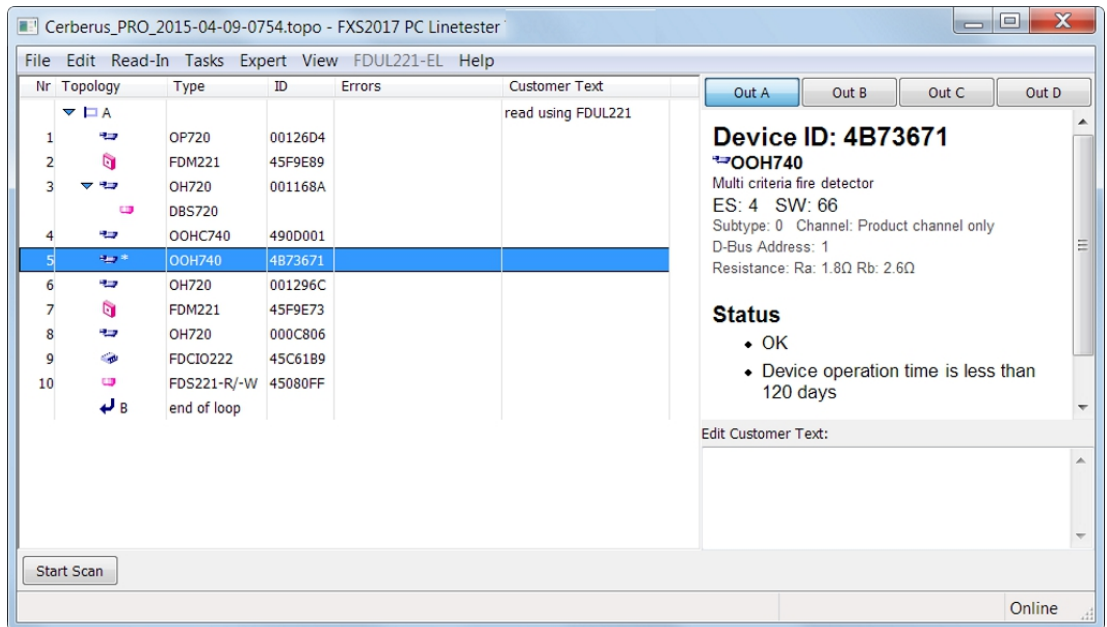
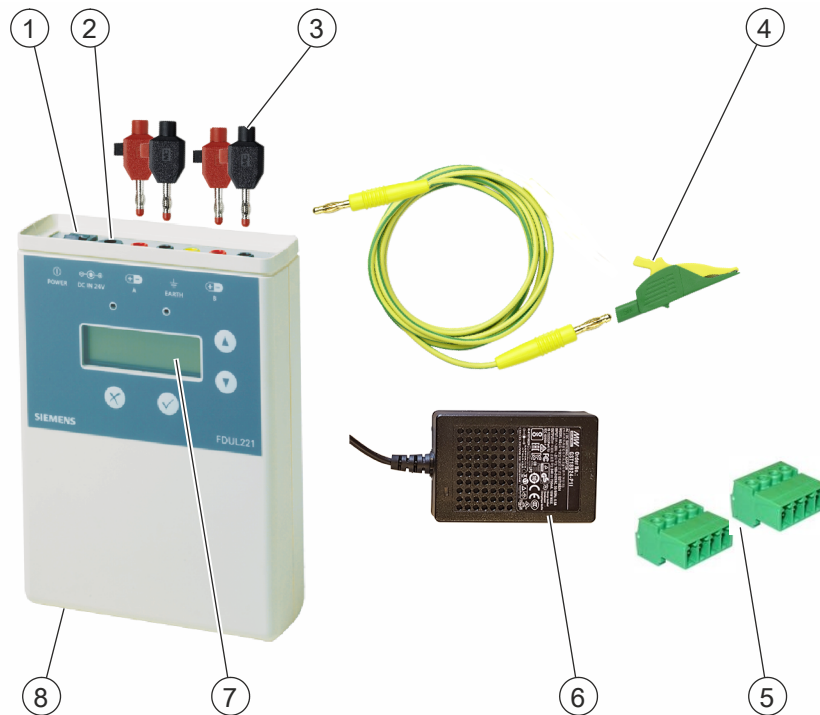

Fig. 2: Line tester software FXS2017

The line tester FDUL221 is a universal device for the final testing of fully installed C-NET fire detector lines if a control panel is not connected. The device is used to for error searches by the electrician, installer, or service technician.



- |   |  |
|---|--|
| <ul style="list-style-type: none"> <li>1 On/Off switch</li> <li>2 USB connection</li> <li>3 Connection of a loop or stub line</li> <li>4 Shielding</li> </ul> | <ul style="list-style-type: none"> <li>5 2x terminal strips for the detector line</li> <li>6 Network adapter</li> <li>7 Display</li> <li>8 Battery compartment on the underside for 2x 9 V lithium batteries, not included in scope of delivery</li> </ul> |
|---|--|



Fig. 3: Scope of delivery FDUL221



**Properties**

- Lightweight, robust design, made from reusable, environmentally friendly material
- Possible to exchange the detector without a ladder or scaffolding up to a room height of 8 m with the help of the telescope rods
- The point detector can be held in all positions. This makes it easier to work efficiently
- Compatible with
  - Telescope rods FDUM291/292
  - Previous straight connectors VR10/11/12/13
  - MP/MT handles and straight connectors

**Function**

Efficient installation and removal of the point detectors below.

Adapter FDUD491 is an accessory part for detector exchanger DX791, which serves to install and remove point detectors OOH740 and OOHC740.

Installation/removal with detector exchanger DX791	Installation/removal with detector exchanger DX791 and adapter FDUD491
OH720	OOH740
OP720	OOHC740
HI720	
HI722	

1	Point detector	Detector exchanger DX791 with suction cap <sup>1)</sup>	Detector exchanger DX791 with adapter FDUD491
2	Detector exchanger DX791		

<sup>1)</sup> The suction cap is used to attach the detector dust cap to and remove it from the detector.



- The detector tester RE6 is used together with a test gas can REF8, REF8-S, or REF8-C. It is designed to test optical smoke detectors, ionization detectors, and CO detectors.
- The detector tester is positioned over the detector for the testing process. Brief pressure causes the test gas to flow into the measuring chamber of the detector and therefore simulate the presence of fire aerosols. After a short period of time, the detector responds and triggers the alarm.
- REF8 and REF8-S are environmentally-friendly test gases and comply with strict environmental regulations. They do, however, contain flammable substances. REF8 is used for the temperature range 0...+40 °C and REF8-S for -20...+40 °C in dry and damp conditions. REF8-S is mainly used for temperatures below 0 °C or for point detectors that only trigger the alarm when there is a high level of smoke density or after longer signal integration.
- REF8-C is used to test the CO functionality of detectors with a CO sensor. REF8-C can be used in dry and damp conditions at temperatures between -20 °C and +50 °C.



When transporting, e.g., in a car, we recommend protecting the detector tester and the test gas cans from heat.

Please observe the notices on the detector tester for operation.



The heat detector tester kit consists of

- 1x heat detector tester
- 2x rechargeable batteries
- 1x charger with 12 V connection cable
- 2x mains cables AC 110/120-220/240 V.

The heat detector tester contains a hot air generator. The heat detector tester is positioned over the detector for the function check. The hot air emitted heats the detector which triggers this alarm.

In high rooms, detectors positioned at an angle can be reached and tested using adapters and telescope rods.

The adapter RE7T-A and telescope rods FDUM291/292 must be ordered separately.



---

The heat detector tester must not be used in electrical switching stations or areas where there is a danger of explosion.

---



The test kit RE8ST consists of

- 1x Testifire 1001-101 tester
- 1x RE8-S smoke capsule
- 2x rechargeable batteries
- 1x charger with 12 V connection cable
- 2x mains cables AC 110/120-220/240 V
- 1x USB cable.

The detector tester contains a smoke capsule. The detector tester is positioned over the detector for the function check. The smoke that is emitted triggers an alarm.

In high rooms, detectors positioned at an angle can be reached and tested using adapters and telescope rods.

The adapter RE7T-A and telescope rods FDUM291/292 must be ordered separately.



---

The detector tester must not be used in electrical switching stations or areas where there is a danger of explosion.

---



Fig. 4:

The test kit RE8STCO consists of

- 1x Testifire 2001-101 tester
- 1x RE8-S smoke capsule
- 1x RE8-CO CO capsule
- 2x rechargeable batteries
- 1x charger with 12 V connection cable
- 2x mains cables AC 110/120-220/240 V
- 1x USB cable.

The detector tester contains a smoke capsule or CO capsule. The detector tester is positioned over the detector for the function check. The smoke or gas that is emitted triggers an alarm.

In high rooms, detectors positioned at an angle can be reached and tested using adapters and telescope rods.

The adapter RE7T-A and telescope rods FDUM291/292 must be ordered separately.



---

The detector tester must not be used in electrical switching stations or areas where there is a danger of explosion.

---

**RE7T-A – Solo719 adapter for FDUM29x**



Mounting adapter for the detector testers RE7T, RE8ST, and RE8STCO on the telescope rods FDUM291 and FDUM292

**RE7T-B1 – Solo770 battery**



Battery as spare part

**RE7T-C1 (Solo727 charger)**



Charger as spare part for charging the batteries RE7T-B1

**RE8-S smoke capsule for RE8ST and RE8STCO**



**RE8-CO CO capsule for RE8STCO**







Properties

- Light and robust yellow plastic pipes, non-conductive material
- Plastic sockets and friction bearings ensure that the pipes run into each other easily.
- Quick spring-type locking mechanisms allow continuous adjustment of the length.
- The pipes can be extended to their maximum length. A stop is used to prevent them from extending further.
- Existing testers can be used.
- The telescope rods cannot be extended.

	<p><b>⚠ WARNING</b></p>
	<p><b>Falling objects</b>                  Danger of injury</p> <ul style="list-style-type: none"> <li>• Always wear a hardhat when working with telescope rods.</li> </ul>

	<p><b>⚠ WARNING</b></p>
	<p><b>Approaching or touching live lines</b>                  Electric shock</p> <ul style="list-style-type: none"> <li>• Only use testers with telescope rods in volt-free areas.</li> </ul>

	<p><b>⚠ CAUTION</b></p>
	<p><b>Uncontrolled movements of sections of rod</b>                  Injuries to hands</p> <ul style="list-style-type: none"> <li>• Keep a tight hold of the section of rod during the insertion process.</li> <li>• Starting at the bottom, insert the sections of rod one after the other, largest diameter first.</li> <li>• Maintain the safety distance between the sections of rod.</li> <li>• Use a spring-type locking mechanism to secure each section of rod.</li> </ul>

## FDUM291

- Light telescope rod for all applications in rooms up to 5.5 m high
- Flap closure for continuous adjustment of the length
- Three-part telescope with tri-oval pipes as practical grip
- Twisting the pipe in the opposite direction is not possible
- Weight: 1.2 kg without tester fitted
- Retracted length 1.6 m, extended length 4.2 m

## FDUM292

- Long and robust telescope rod for all applications in rooms up to 8 m high
- Flip top closure for continuous adjustment of the length
- Sturdy four-sided telescope with round pipes
- Weight: 3.4 kg, without tester fitted
- Retracted length 2.1 m, extended length 7.3 m

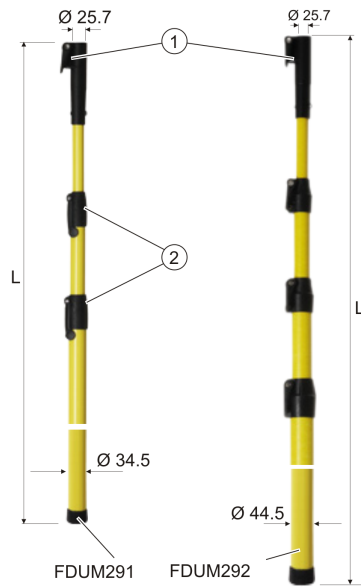

- 1 Flip top closure
- 2 Flap closure

## Detector tester RE10, alarm test filter TF04

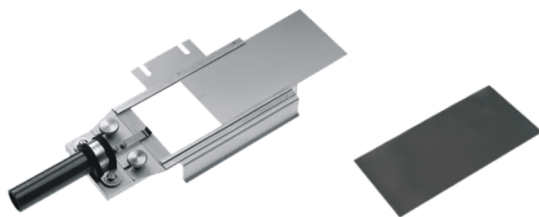

- For undertaking a function check on the linear smoke detectors. The alarm test filter TF04 is inserted into the detector tester in accordance with the type of detector to be tested.  
An alarm test filter is also included in the adjustment kit FDLU291.
- For testing, the detector tester is held in front of the detector lens in the IR beam. The detector responds after a few seconds.

## Adjustment kit FDLU291



The adjustment kit is used for commissioning the linear smoke detector FDL241-9. The lens of the linear smoke detector can be efficiently aligned to the reflector by one man.

### Scope of delivery:

- Case with adjustment device
- Alarm test filter
- Visor
- Magnet
- Spiral cable
- MC link cable
- 9 V battery
- Suspension fixture with cable grippers and chain

## LE3 Test lamp



The test lamp LE3 is used to test the function of all flame detectors over distances up to 10 m. It is housed in a transportable case together with the required accessories. In addition, the case enables the test lamp to be kept in a dust-free condition.

The quartz-halogen lamp used creates an intense ray of light. This helps to align the lamp on the detector which is to be tested. During the detector test, the ray of light is modulated. The luminous intensity can be set in accordance with the distance.

The power is supplied by a rechargeable battery. Since the color of the light depends on the charge state of the battery, it must always be charged in buffer mode. A special charger is available for this.



### **⚠ WARNING**

#### **Use of test lamps in areas at risk of explosion**

Risk of explosion

- Do not use the test lamp LE3 in areas at risk of explosion.

## Test lamp Stabex HF



The test lamp Stabex HF is used to test the function of intrinsically safe flame detectors in zone 1 or 2 areas at risk of explosion.

The lamp is used directly in front of the detector for the test. The ray of light must be pulsed with the sliding switch at half-second intervals.



### **⚠ WARNING**

#### **Opening test lamps in areas at risk of explosion**

Risk of explosion

- Do not open the test lamp Stabex HF in areas at risk of explosion.

**Technical data**

<b>Line tester FDUL221</b>	
Supply voltage	Min. DC 10 V, max. DC 30 V
Battery or via network adapter	Lithium manganese dioxide battery <sup>1</sup> , 2x 9 V AC 240 V / DC 24 V, 750 mA
Power consumption during measurement	Depends on the number of devices and the display backlight
Detector line voltage: C-NET (FS720) C-NET	DC 32 V DC 28 V
Max. detector key figures (MK) per line: MK with network adapter MK with battery	Min. 550 Min. 150
Operating temperature	-25...+40 °C
Storage temperature without battery Storage temperature with battery	-30...+75 °C -25...+60 °C
Air humidity (no condensation permitted)	≤95 % rel.

<sup>1</sup> ULTRALIFE U9VL or U9VL-J or EVE CR9V/P-S

<b>Detector exchanger DX791</b>	
Dimensions Ø x H: With suction cap With adapter FDUD491	82 x 175 mm 87 x 178 mm

<b>Detector tester RE6</b>	
Operating temperature: REF8 REF8-S REF8-C	0...+40 °C -20...+40 °C -20...+50 °C
Storage temperature	-20...+40 °C
Number of detector tests, depending on detector type	Max. 400

<b>Heat detector tester RE7T</b>	
Operating temperature	5...+45 °C
Storage temperature	-10...+50 °C
Air humidity (no condensation permitted)	≤95 % rel.
Voltage	Auto: DC 12 V Mains: AC 110/120-220/240 V
Charging time	Approx. 1 hour per battery

<b>Detector tester RE8ST/RE8STCO</b>	
Operating temperature	5...+45 °C
Storage temperature	-10...+50 °C
Air humidity (no condensation permitted)	≤ 95 % rel.
Voltage	Auto: DC 12 V Mains: AC 110/120-220/240 V
Charging time	Approx. 1 hour per battery

<b>Adjustment kit FDLU291</b>	
Dimensions of the adjustment device	120 x 65 x 22 mm

<b>Test lamp LE3</b>	
Power consumption	50 W
Modulation frequency	4 Hz
Max. distance for alarm activation	10 m
Measuring capacity with charged battery and max. distance Number of detectors	~ 50
Operating and storage temperature	-20...+ 45 °C
Areas of use	Areas not at risk of explosion
Incandescent lamp	Halogen 12 V / 50 W
Battery	12 V / 7 Ah, lead, gas tight
Charging time	Min. 16 h
Power supply connection charger	AC 220 / 240 V, 50...60 Hz
Dimensions:	
Test lamp	178 x 180 x 369 mm
Battery	153 x 103 x 67 mm

<b>Test lamp Stabex HF</b>	
Max. distance for alarm activation	A few cm
Operating and storage temperature	-20...+40 °C
Explosion protection	II 2 G EEx ib e IIC T4
Ex approvals	PTB 98 ATEX 2062
Areas of use	Zones 1 and 2
Protection category	IP65
Incandescent lamp	Halogen 2.8 V / 0.5 A
Battery	2x alkaline batteries 1.5 V Mono cell UM-1

## Disposal



The device is considered an electronic device for disposal in accordance with European Directive and may not be disposed of as domestic waste.

- Use only designated channels for disposing the devices.
- Comply with all local and currently applicable laws and regulations.
- Dispose of empty batteries at designated collection points.



**Details for ordering**

	Type	Order number	Designation	Weight
Line tester	FDUL221	A5Q00004397	Line tester with line connection kit FDUL221-A, power unit set FDUL221-B and carry case	1.567 kg
Accessories	–	A5Q00004142	Lithium manganese dioxide battery 9 V / 1.2 Ah	0.035 kg
Spare part	FDUL221-A	A5Q00008436	Line connection kit	0.088 kg
	FDUL221-B	A5Q00008437	Power unit kit	0.278 kg
	FDUL221-C	A5Q00008438	RS232 PC cable as spare part for FDUL221 with RS232 interface	0.037 kg
	FDUL221-3	S54370-S30-A1	Line tester without accessories	0.440 kg

	Type	Order number	Designation	Weight
Detector exchanger	DX791	S54319-F6-A1	Detector exchanger	0.082 kg
Adapter	FDUD491	S54319-F18-A1	Adapter	0.034 kg

	Type	Order number	Designation	Weight
Detector tester	RE6	BPZ:3680300001	Detector tester for smoke detectors	0.950 kg
Accessories	REF8	A5Q00011687	Test gas can	0.194 kg
	REF8-S	A5Q00011688	Test gas can	0.186 kg
	REF8-C	S54370-N2-A1	Test gas can CO	0.203 kg

	Type	Order number	Designation	Weight
Detector tester	RE7T	S54370-S3-A1	Solo461 heat detector tester kit consisting of tester, 2 batteries, charger, cable	2.800 kg
Accessories	RE7T-A	S54370-N4-A1	Solo719 adapter for FDUM29x	0.260 kg
Spare part	RE7T-B1	S54370-N7-A1	Solo770 battery for RE7T	1.090 kg
	RE7T-C1	S54370-N8-A1	Solo727 charger for RE7T	1.210 kg

	Type	Order number	Designation	Weight
Detector tester	RE8ST	S54370-S23-A1	Testfire 1001-101 ST test kit	3.470 kg
	RE8STCO	S54370-S24-A1	Testfire 2001-101 STCO test kit	3.750 kg
Capsule	RE8-S	S54370-N25-A1	TS3 smoke capsules, 6 items	0.079 kg
	RE8-CO	S54370-N22-A1	TS3 CO capsules, 6 items	0.077 kg
Accessories	RE7T-A	S54370-N4-A1	Solo719 adapter for FDUM29x	0.260 kg
Spare part	RE7T-B1	S54370-N7-A1	Solo770 battery for RE7T <sup>1)</sup>	1.090 kg
	RE7T-C1	S54370-N8-A1	Solo727 charger for RE7T <sup>1)</sup>	1.210 kg

<sup>1</sup> Compatible with RE8ST and RE8STCO

	Type	Order number	Designation	Weight
Telescope rod	FDUM291	A5Q00004996	Telescope rod – three-part telescope with tri-oval pipes, 1.6 m / 4.2 m	1.960 kg
Spare part	–	A5Q00009787	Lever with screw and nut, flip top closure	0.023 kg
	–	A5Q00009786	Adapter with lever, screw, and nut incl. mounting and sleeve bolt	0.088 kg
	–	A5Q00009788	Small flap with screw and nut, flap closure	0.015 kg
	–	A5Q00009789	Large flap with screw and nut, flap closure	0.016 kg

	Type	Order number	Designation	Weight
Telescope rod	FDUM292	A5Q00004997	Telescope rod – four-part telescope with round pipes, 2.1 m / 7.3 m	4.480 kg
Spare part	–	A5Q00009787	Lever with screw and nut, flip top closure	0.023 kg
	–	A5Q00009786	Adapter with lever, screw, and nut incl. mounting and sleeve bolt	0.088 kg
	Type	Order number	Designation	Weight
Detector tester	RE10	BPZ:3685190001	Detector tester for linear smoke detectors	0.345 kg
Alarm test filter for RE10	TF04	BPZ:4931090001	Alarm test filter, absorption 77 %	0.005 kg
	Type	Order number	Designation	Weight
Adjustment kit	FDLU291	A5Q00004905	Adjustment kit for linear smoke detector incl. case	0.840 kg
	Type	Order number	Designation	Weight
Test lamp	LE3	BPZ:3669510001	Test lamp for flame detector incl. case and charger, without battery	5.260 kg
Accessories	FA2003-A1	A5Q00019353	Battery 12 V / 7 Ah / VdS	2.293 kg
Spare part		BPZ:3679630001	Halogen lamp 12 V / 50 W	0.395 kg
	Type	Order number	Designation	Weight
Test lamp	Stabex HF	BPZ:4620910001	Test lamp for areas at risk of explosion	0.175 kg

## Applicable documents

Document ID	Name
A6V10229261	List of compatibility (for 'Cerberus™ PRO' product line)
A6V10201731	Installation Detector exchanger DX791, adapter for detector exchanger FDUD491
A6V10254740	Operating instructions Solo461 heat detector tester kit RE7T
A6V10387053	Installation RE8ST Testifire 1001-101 ST test kit, RE8STCO Testifire 2001-101 STCO test kit
A6V10260320	Operation RE7T-C Solo726 charger for RE7T-B
A6V11432110	Operation RE7T-C1 Solo727 charger for RE7T-B1 Solo770
008250	Technical Manual Line tester FDUL221
A6V10395483	Line tester – operating instructions for electricians
007016	Technical manual Linear smoke detector FDL241-9
000257	Operating instructions Test lamp LE3
<b>Safety data sheets</b>	
A5Q00011687D	Safety data sheet REF8
A5Q00011688D	Safety data sheet REF8-S
A5Q00035329C	Safety data sheet REF8-C

MCL-USB adapter (radio) FDUZ227, see data sheet A6V10355605.

Issued by  
Siemens Switzerland Ltd  
Smart Infrastructure  
Global Headquarters  
Theilerstrasse 1a  
CH-6300 Zug  
+41 58 724 2424  
[www.siemens.com/buildingtechnologies](http://www.siemens.com/buildingtechnologies)

© Siemens Switzerland Ltd, 2008  
Technical specifications and availability subject to change without notice.

---

Document ID    A6V10203222\_n\_en\_--  
Edition        2021-09-03